

General tolerances ISO 2768-m						Index	Date	Visum	Modification	Index	Date	Visum	Modification
Basic-size	...6	> 6 ...30	> 30 ...120	>120 ...400	> 400 ...1000								
medium	±0.1	±0.2	±0.3	±0.5	±0.8								

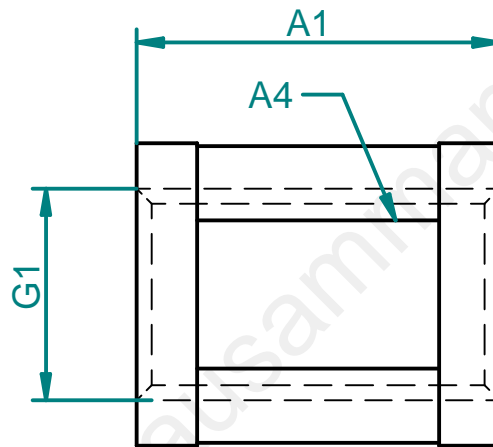

Specifications points D,K,H	
D= doc.points	
K= critical	
H= main	

Accord-draw.no.: Origin-draw.no.: Replacement for:	Material:			
	Kunststoff			
	Scale			
	HAUSAMMANN KOMONENTEN PRODUKTION SYSTEME			
38.258		Solid Edge	Format	Index
			A4	00
© 2010, Für dieses Dokument behalten wir uns alle Rechte vor.		© 2 010, Nous nous reservons tous les droits sur ce document		© 2 010, We reserve all rights in connection with this document